

PROFMOOD

complements



preview

PR
OF

« CONTENTS »

PAG. 04
CHAPTER 01 - SCREENS AND ACCESSORIES

PAG. 12
CHAPTER 02 - INDOOR PLANTERS

PAG. 14
CHAPTER 03 - UMBRELLA STAND

PAG. 16
CHAPTER 04 - WASTEPAPER BASKETS

PAG. 20
CHAPTER 05 - MIRRORS

PAG. 22
CHAPTER 06 - CARPETS

PAG. 32
CHAPTER 07 - DESK SET

PAG. 34
CHAPTER 08 - VASES AND BOWLS







SHADE
PARAVENTI
SCREENS
PARAVENTS

IT— Shade sono paraventi modulari da utilizzare per creare aree di privacy e dividere gli spazi. I moduli, disponibili in tre misure, hanno struttura in legno rivestita in tessuto e preziosa cornice perimetrale in ottone spazzolato. Ampia possibilità di personalizzazione grazie alle gamma di tessuti proposta e alle diverse dimensioni, che permettono combinazione di moduli multipli, da comporre liberamente nello spazio.

EN— Shade are modular screens to guarantee privacy and divide up spaces. Available in three different sizes, the modules consist of a fabric covered wood panel with a refined brushed brass finish frame. The possibilities for customisation are vast, thanks to the range of fabrics proposed and different available sizes, enabling multiple modules to be combined to compose the space freely.

F— Shade sont cloisons modulaires pour agencer des espaces tranquilles et créer des zones de travail séparées. Les modules disponibles en trois tailles différentes ont une ossature en bois revêtue de tissu, ainsi qu'un cadre précieux en finition laiton brossé. Les cloisons sont personnalisables grâce à la gamme de tissus et aux différentes tailles disponibles, ce qui permet d'assortir plusieurs modules et d'agencer librement l'espace de vos bureaux.

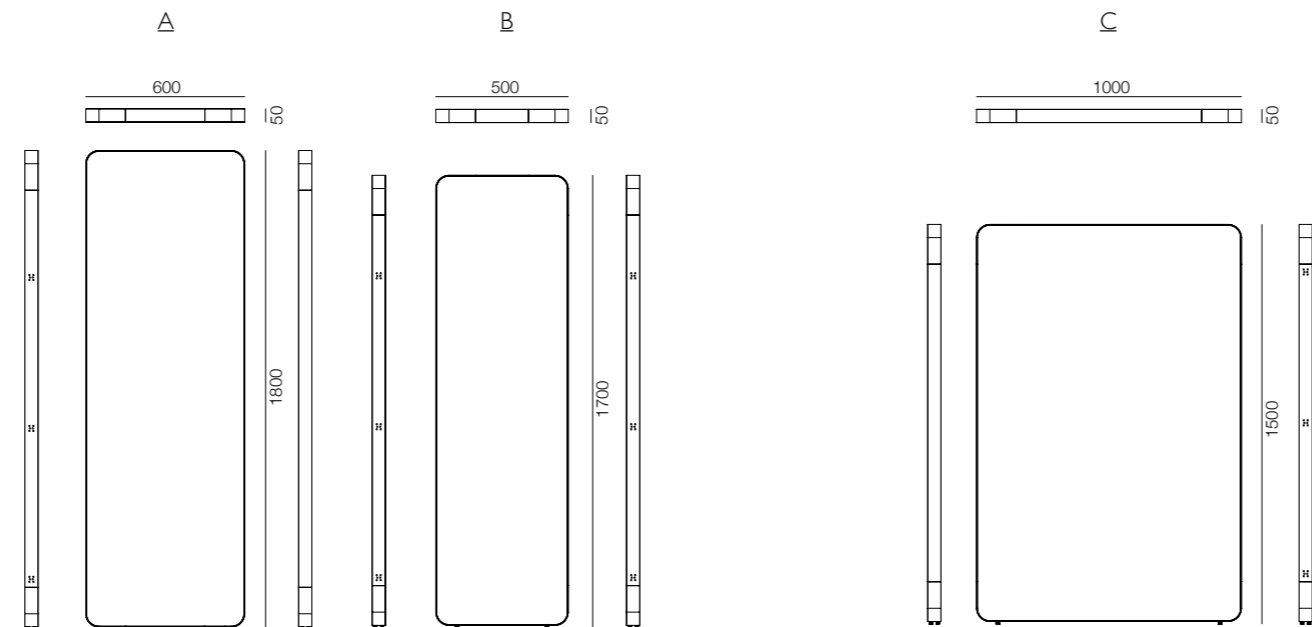

JACKIE
ACCESSORI PER PARAVENTI
ACCESSORIES FOR SCREENS
ACCESSOIRES POUR PARAVENTS

IT— Semplice e raffinata, Jackie è una collezione di accessori e appendiabiti da abbinare alla collezione dei paraventi Shade. È composta da due elementi liberamente posizionabili: un gancio appendiabiti e una specchiera con cornice e vaschetta svuota tasche rivestita in pelle per riporre piccoli oggetti. Entrambi sono realizzati in acciaio con finitura ottone spazzolato.

EN— Simple and refined, Jackie is a collection of clothes hanging and accessories to use in combination with the Shade collection of screens. It consists of two freely positionable elements: a clothes hook and a mirror with surround and leather covered pocket-emptier tray. Both are in steel with brushed brass finish.

F— Épurée et raffinée, Jackie est une collection d'accessoires et porte-manteaux à assortir à la collection de cloisons Shade. Ce dernier modèle est composé de deux éléments à agencer librement: un crochet porte-manteaux et un miroir avec un cadre et un vide-poche, revêtu en cuir pour y déposer des petits objets. Ils sont tous deux réalisés en acier avec une finition laiton brossé.

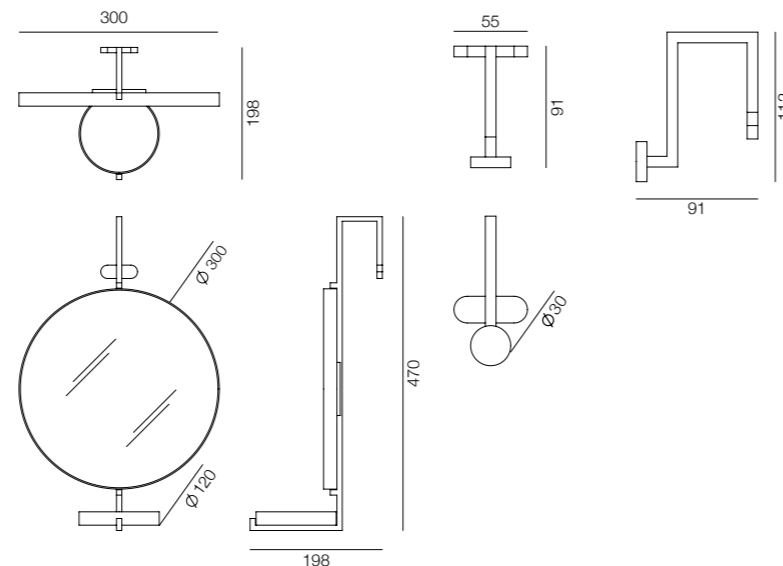



JACKIE

SPECCHIO APPENDIABILI A PARETE
WALL MOUNTED MIRROR CLOTHES RACK
MIRROIR PORTEMANTEAU À FIXER

IT— Semplice e raffinata, Jackie è una collezione di appendiabiti a parete composta da una barra in legno rivestita in pelle con cornice perimetrale metallica. È dotata di due ganci appendiabiti e una specchiera con cornice e vaschetta svuota tasche con fondo in pelle per riporre piccoli oggetti. Tutte le parti metalliche sono in acciaio con finitura ottone spazzolato.

EN— Simple and refined, Jackie is a collection of clothes hanging for wall-mounting use. It consists of a leather covered wood bar with metal frame. It has two clothes hooks and a mirror with surround and pocket-emptier tray with leather bottom. All metal parts are in steel with brushed brass finish.

F— Épurée et raffinée, Jackie est une collection de portemanteaux pouvant être fixés au mur. Le modèle mural est composé d'une barre en bois revêtue de cuir et entourée d'un cadre métallique. Il est équipé de deux crochets porte-manteaux et d'un miroir avec un cadre et un vide-poche, dont le fond est revêtu de cuir pour y déposer des petits objets. Tous les composants métalliques sont en acier avec une finition laiton brossé.

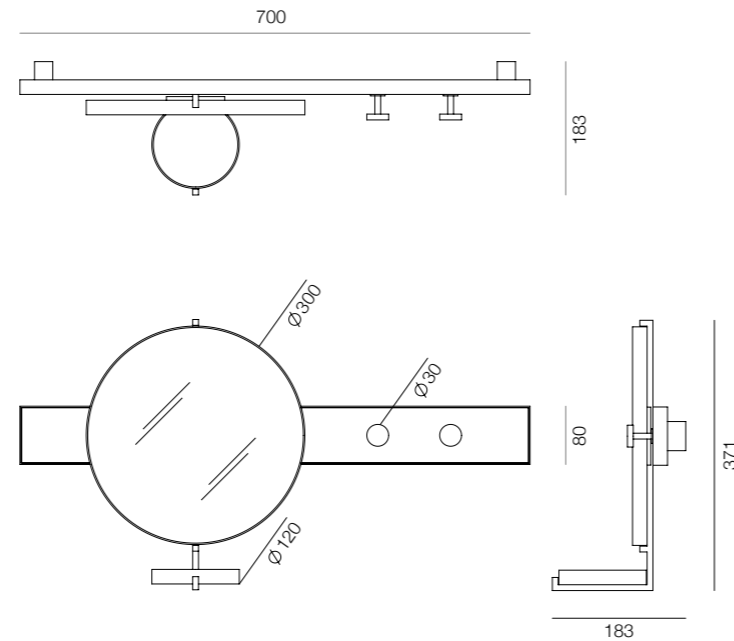



JACKIE
 APPENDIABITI A PARETE
 WALL MOUNTED CLOTHES RACK
 PORTEMANTEAU À FIXER

IT— Semplice e raffinata, Jackie è una collezione di appendiabiti a parete composta da una barra in legno rivestita in pelle con cornice perimetrale metallica. È dotata di cinque ganci appendiabiti. Tutte le parti metalliche sono in acciaio con finitura ottone spazzolato.

EN— Simple and refined, Jackie is a collection of clothes hanging for wall-mounting use. It consists of a leather covered wood bar with metal frame. It has five clothes hooks. All metal parts are in steel with brushed brass finish.

F— Épurée et raffinée, Jackie est une collection de portemanteaux pouvant être fixés au mur. Le modèle mural est composé d'une barre en bois revêtue de cuir et entourée d'un cadre métallique. Il est équipé de cinq crochets porte-manteaux. Tous les composants métalliques sont en acier avec une finition laiton brossé.

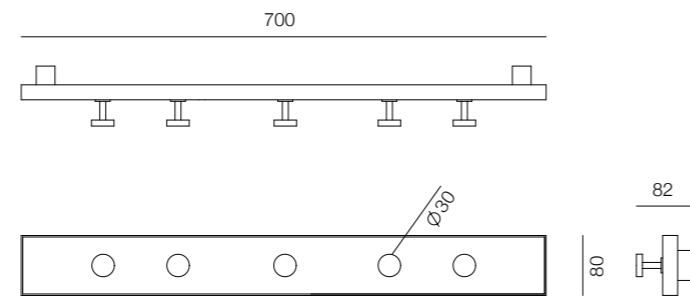



LOUISE
 FIORIERE DA INTERNO
 INDOOR PLANTERS
 PLANTEURS D'INTÉRIEUR

IT— Louise sono fioriere quadrate e rettangolari dalle forme essenziali proposte in tre varianti dimensionali, da utilizzare singolarmente o riunite in composizioni. La struttura metallica è in elegante finitura ottone e ed è rivestita in gres Calacatta oro, nero Marquina e Emperador dark. Sono dotate di ruote a scomparsa totale. Preziose e sofisticate, divengono veri e propri elementi di arredo per interni, perfette per ambienti lavorativi e domestici.

EN— Louise are square and rectangular planters with essential shapes in three different sizes to use singly or in compositions. The metal structure has a brass finish and is clad with Calacatta gold, Marquina black and Emperador dark stoneware. They are equipped with recessed wheels. Refined and sophisticated, they become genuine interior design accessories, perfect for both work and home environments.

F— Louise sont trois tailles différentes de bacs à fleurs, carrés et rectangulaires, aux formes minimalistes sont disponibles: à utiliser seuls ou assortis les uns aux autres. Ils sont équipés de roues cachées. La structure métallique est en finition laiton avec un revêtement en grès Calacatta or, noir Marquina et Emperador dark. Précieux et raffinés, ces bacs à fleurs s'insèrent parfaitement dans la décoration d'intérieur, idéaux dans des espaces de travail et chez soi.

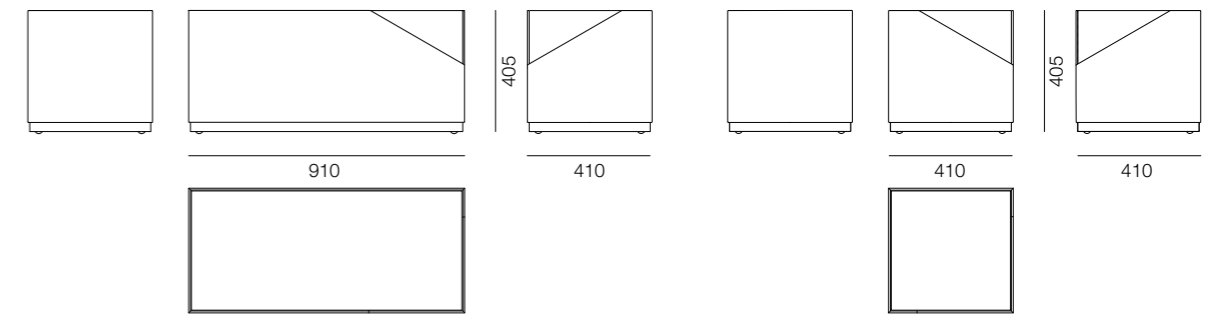
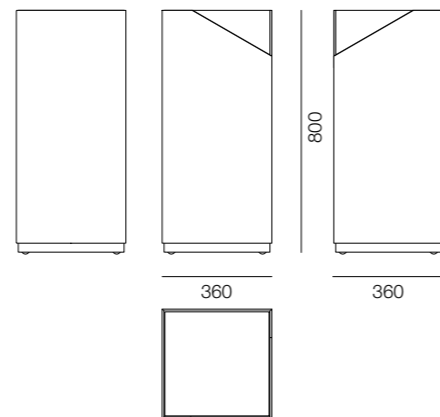

LOUISE
PORTAOMBRELLI
UMBRELLA STAND
PORTE PARAPLUIE



LOUISE
GETTACARTE
WASTEPAPER
CORBEILLE À PAPIER



SQUARE
GETTACARTE
WASTEPAPER
CORBEILLE À PAPIER





MOON - JOSEPHINE
 SPECCHIERE A PARETE
 WALL MIRRORS
 MIROIRS MURAL

IT— In questa pagina, specchiera rotonda Moon con scocca a guscio in acciaio verniciato finitura ottone. Monta a filo esterno uno specchio brunito, impreziosito da una bisellatura perimetrale.
 Nella pagina seguente, specchiera ovali Josephine con elegante cornice perimetrale in acciaio verniciato finitura ottone e specchio montato a filo interno.

EN— On this page, Moon round mirror with shell in painted brass steel finish. A burnished mirror is assembled flush with the outside, embellished with a perimeter bevel.
 On the next page, Josephine oval mirrors with elegant perimetrical frame in painted steel brass finish and mirror mounted flush with the inside.

F— Sur cette page, miroir rond Moon avec coque en acier peint en laiton. Monter un miroir bruni affleurant à l'extérieur, agrémenté d'un biseau de périmètre.
 Sur la page suivante, les miroirs ovales Josephine avec un cadre périmétrique élégant en acier peint en finition laiton et miroir monté à l'intérieur.

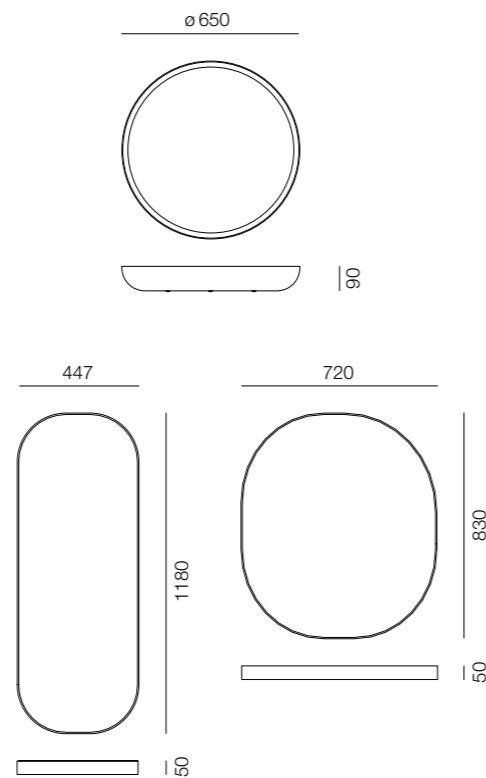



SHINE
TAPPETI
RUGS
TAPIS

IT— Shine è una collezione di tappeti tinta unita in tre varianti di forma composti da 100% PA. Il manto superficiale è in spessore 10 mm con riflessi morbidi e naturali, mentre il sottofondo è costituito da un doppio fondo di supporto.

EN— Shine is a collection of rugs in plain colour available in three different shapes and made of 100% PA. The 10 mm thick surface layer with soft natural lights is supported by a double backing.

F— Shine est une collection de tapis teinte unie disponibles en trois formes différentes, 100% PA. Des reflets délicats et naturels sont visibles dans la couche en surface de 10 mm d'épaisseur, avec un double fond servant d'appui.

TINTA UNITA
SOLID COLOR
COULEUR UNIE

0850 grigio-grey-gris

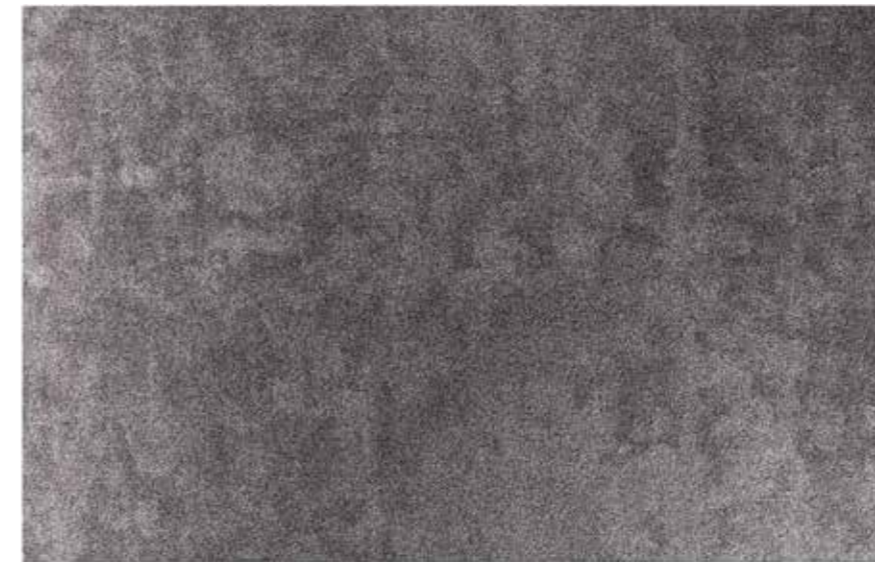

0850 grigio-grey-gris



0880 perla-perle-perle 0850 grigio-grey-gris 0820 basalto-basalt-basalte 0800 nero-black-noir



0430 visone-mink-vison 0280 castoro-beaver-castor 0200 cacao-cocoa-cacao 0321 rame-copper-cuivre



0731 petrolio-petroleum-pétrole 0081 viola-violet-violet 0121 rosso-red-rouge 0791 blu-blue-bleu

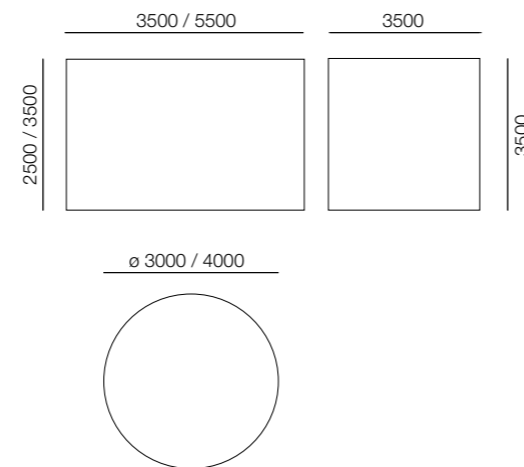

0850 grigio-grey-gris

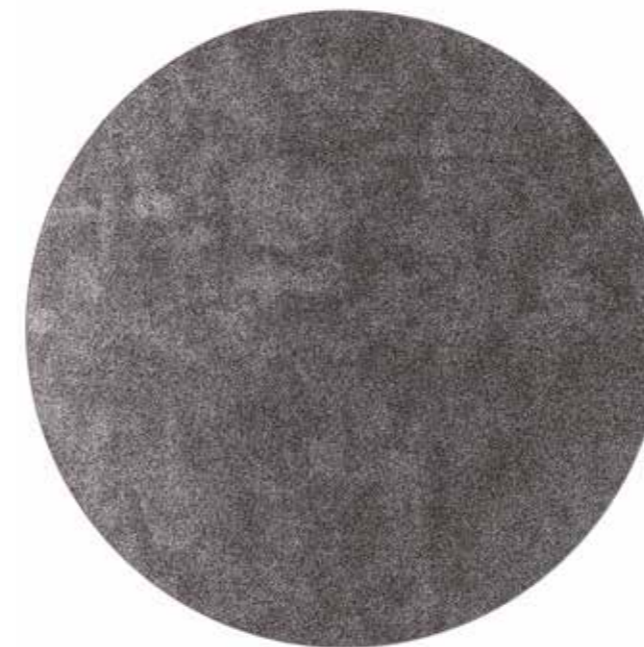



RAY
TAPPETI
RUGS
TAPIS

IT— Ray è una collezione di tappeti composti da fasce colorate disponibili in sei variazioni cromatiche che abbracciano le tonalità calde. Sono proposti in tre varianti di forma e composti da 100% PA. Il manto superficiale è in spessore 10 mm con riflessi morbidi e naturali, mentre il sottofondo è costituito da un doppio fondo di supporto.

EN— Ray is a collection of rugs consisting of coloured strips available in six colour variations in warm shades. Available in three different shapes and made of 100% PA. The 10 mm thick surface layer with soft natural lights is supported by a double backing.

F— Ray est une collection de tapis composés de différentes bandes colorées disponibles en une palette de six couleurs chaudes. Trois formes différentes de tapis sont disponibles, 100% PA. Des reflets délicats et naturels sont visibles dans la couche en surface de 10 mm d'épaisseur, avec un double fond servant d'appui.



0430 visone-mink-vison 0280 castoro-beaver-castor 0200 cacao-cocoa-cacao 0321 rame-copper-cuivre



0731 petrolio-petroleum-pétrole 0081 viola-violet-violet 0121 rosso-red-rouge 0791 blu-blue-bleu

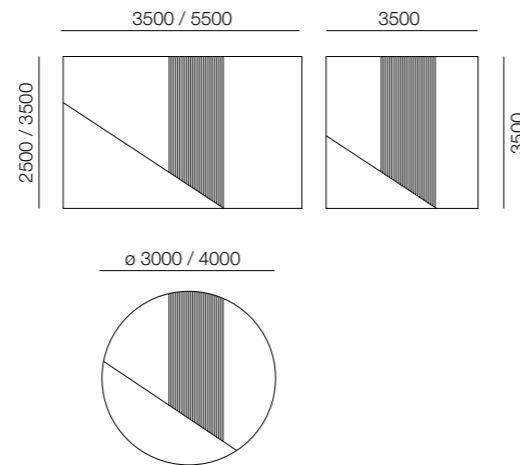

3 COLORI TONI CALDI
3 COLORS WARM TONES
3 COULEURS TONS CHAUDS

0280 castoro-beaver-castor

0430 visone-mink-vison

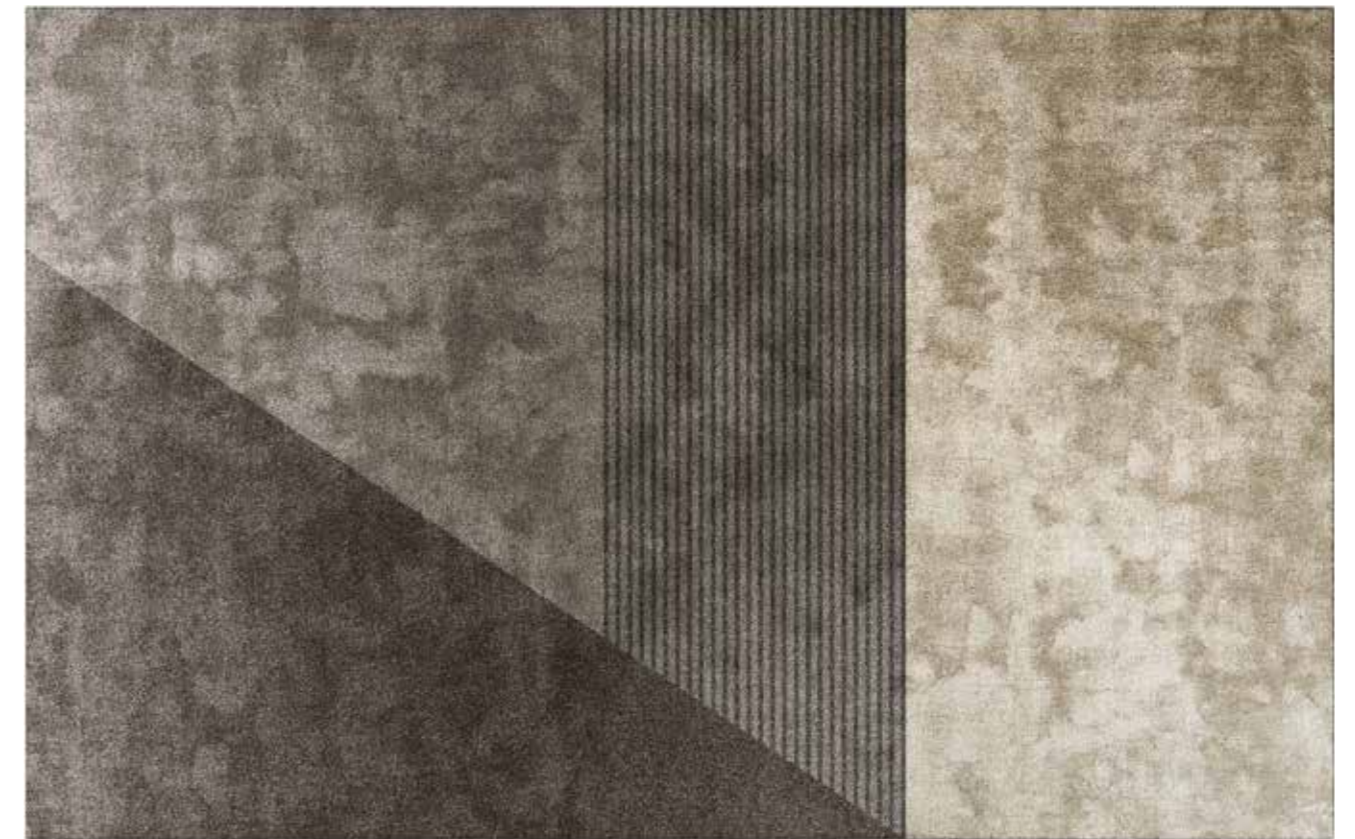

0200 cacao-cocoa-cacao



0280 castoro-beaver-castor

0430 visone-mink-vison

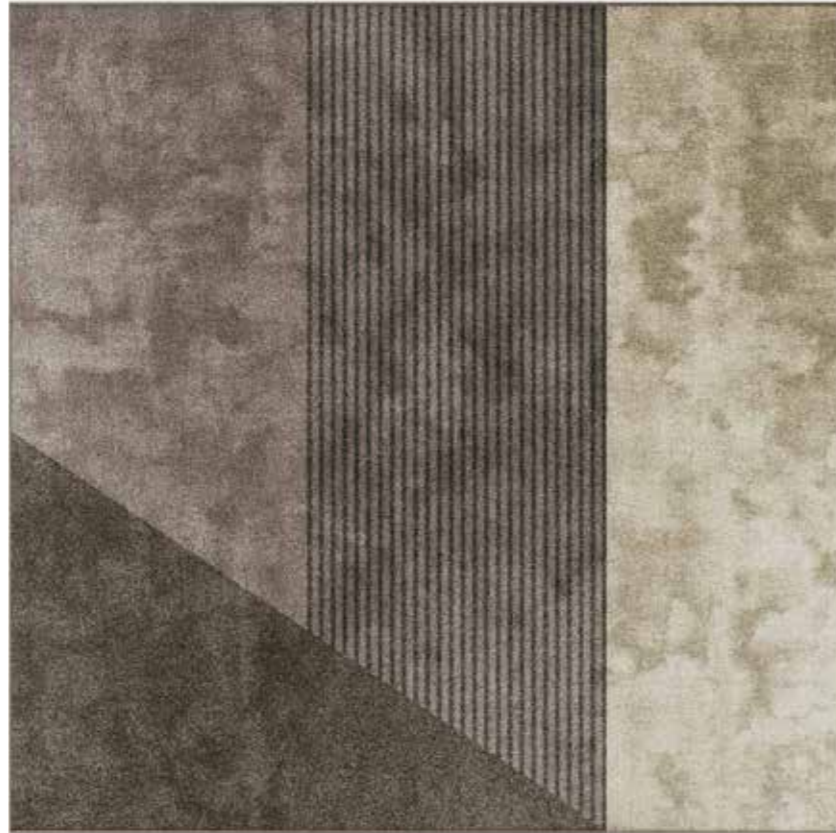

0200 cacao-cocoa-cacao

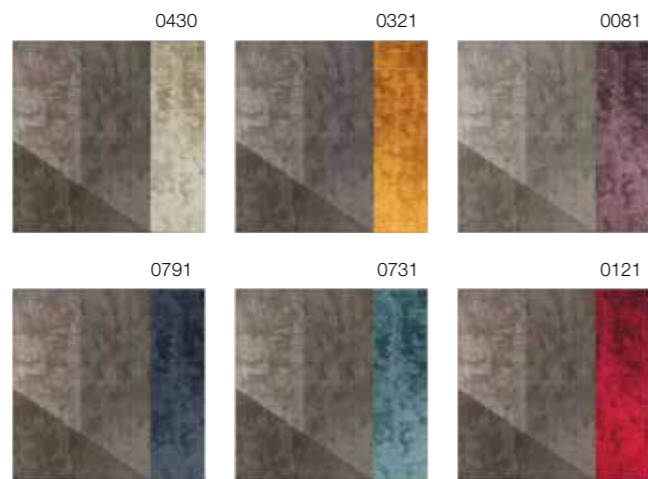

0280 castoro-beaver-castor

0430 visone-mink-vison

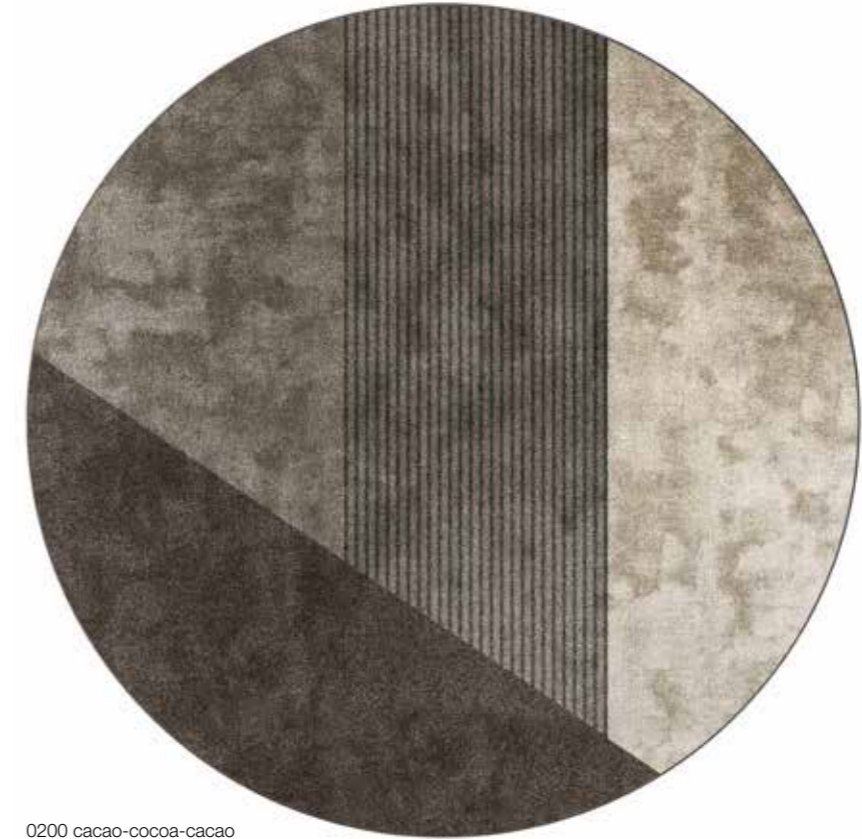

0200 cacao-cocoa-cacao

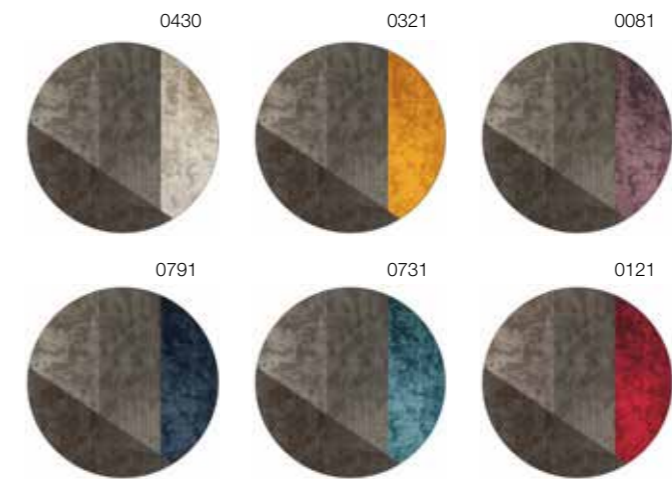



RAY
TAPPETI
RUGS
TAPIS

IT— Ray è una collezione di tappeti composti da fasce colorate disponibili in sette variazioni cromatiche che abbracciano le tonalità fredde. Sono proposti in tre varianti di forma e composti da 100% PA. Il manto superficiale è in spessore 10 mm con riflessi morbidi e naturali, mentre il sottofondo è costituito da un doppio fondo di supporto.

EN— Ray is a collection of rugs consisting of coloured strips available in seven colour variations in cold shades. Available in three different shapes and made of 100% PA. The 10 mm thick surface layer with soft natural lights is supported by a double backing.

F— Ray est une collection de tapis composés de différentes bandes colorées disponibles en une palette de sept couleurs froides. Trois tailles différentes de tapis sont disponibles, 100% PA. Des reflets délicats et naturels sont visibles dans la couche en surface de 10 mm d'épaisseur, avec un double fond servant d'appui.



0880 perla-perle-perle 0850 grigio-grey-gris 0820 basalto-basalt-basalte 0800 nero-black-noir



0731 petrolio-petroleum-pétrole 0081 viola-violet-violet 0121 rosso-red-rouge 0791 blu-blue-bleu



0321 rame-copper-cuivre

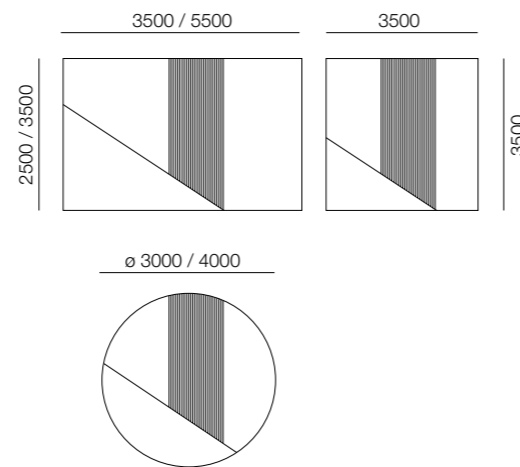

3 COLORI TONI FREDDI
3 COLORS COOL TONES
3 COULEURS TONS FROIDS

0850 grigio-grey-gris

0800 nero-black-noir

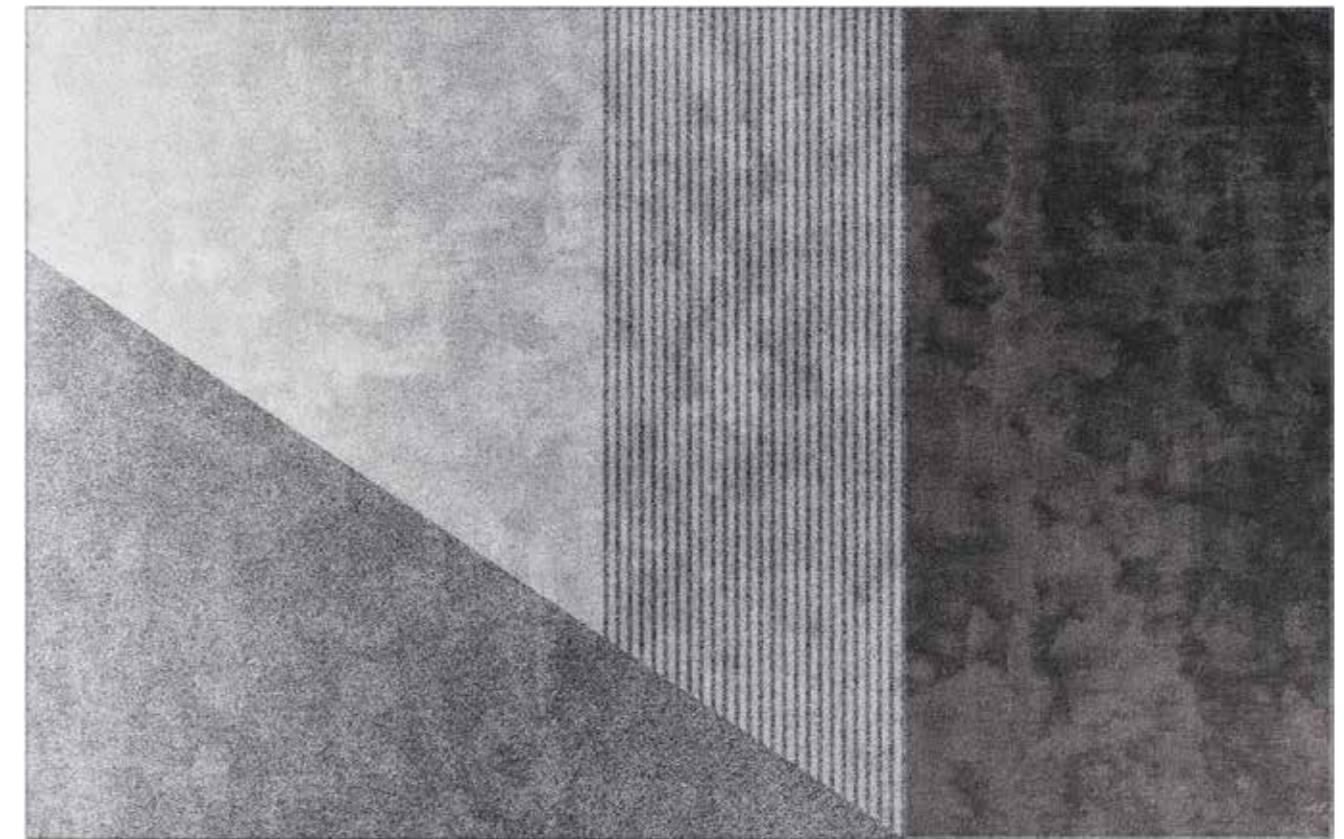

0820 basalto-basalt-basalte

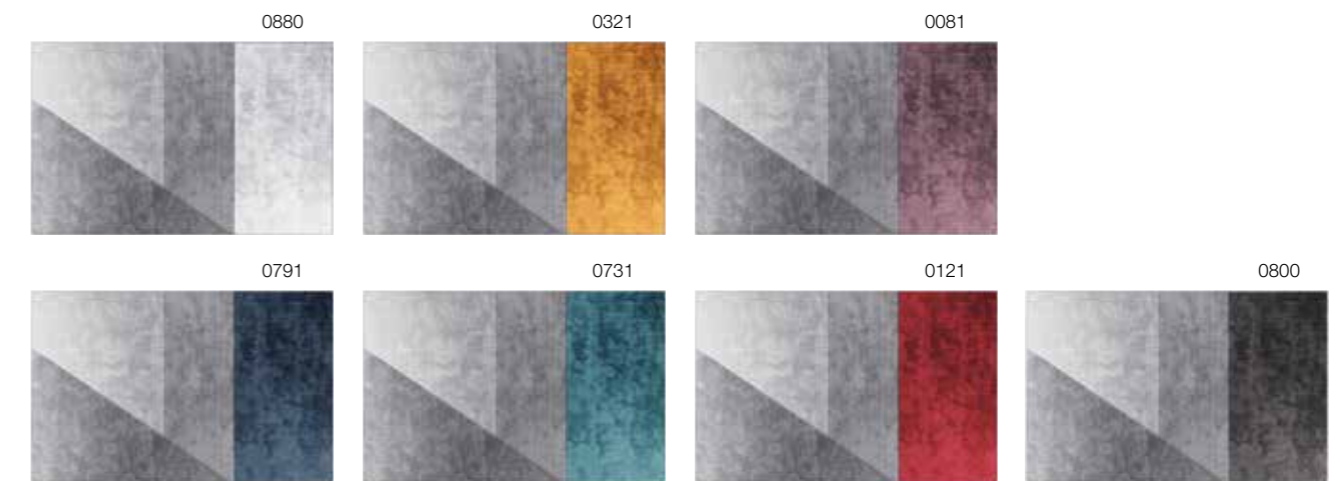

0880

0321

0081

0791

0731

0121

0800

0850 grigio-grey-gris

0800 nero-black-noir

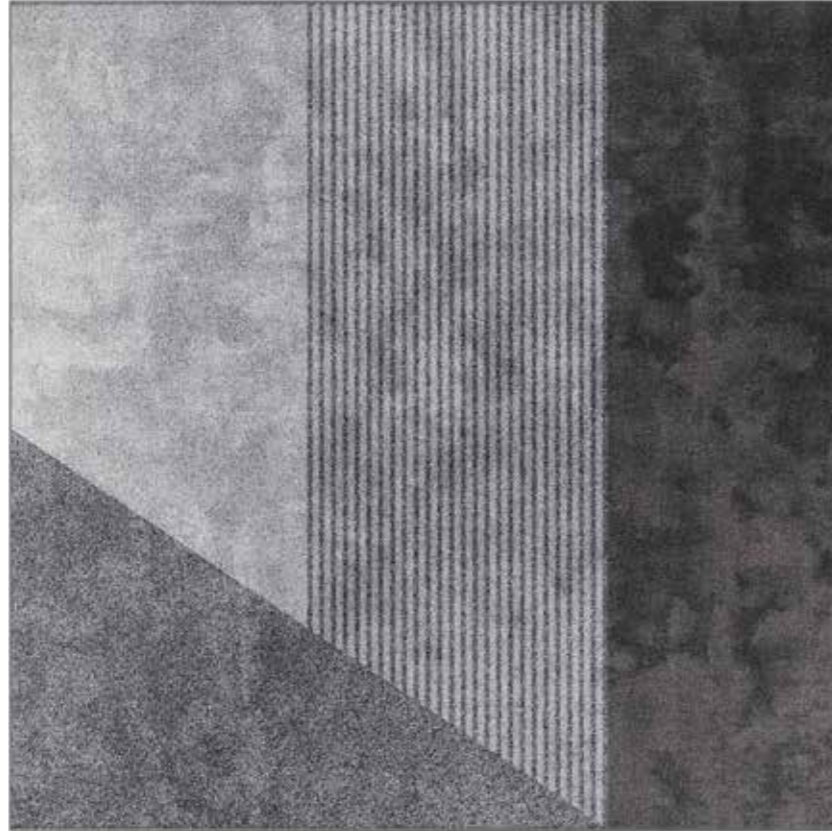

0820 basalto-basalt-basalte

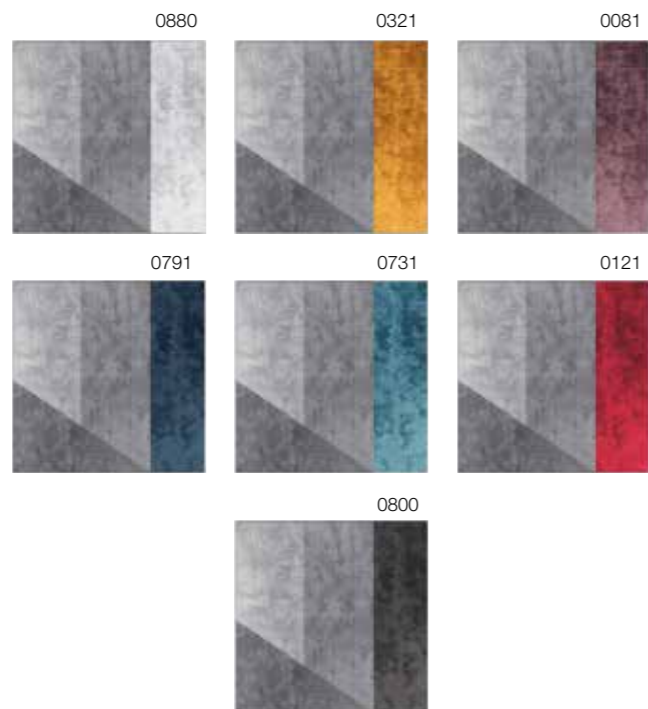

0850 grigio-grey-gris

0800 nero-black-noir

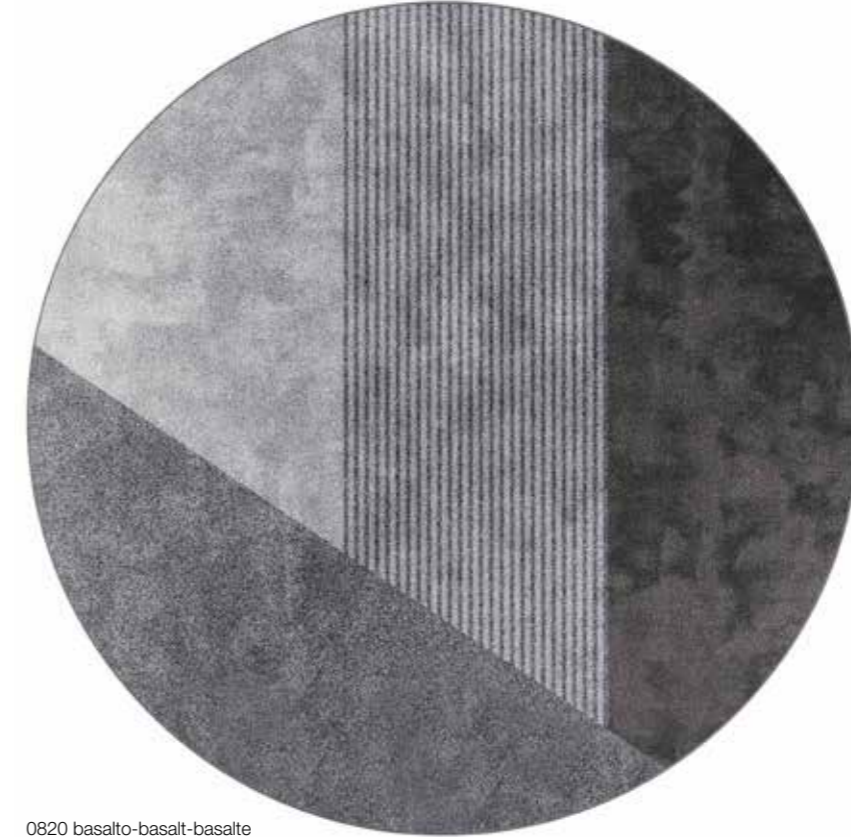

0820 basalto-basalt-basalte

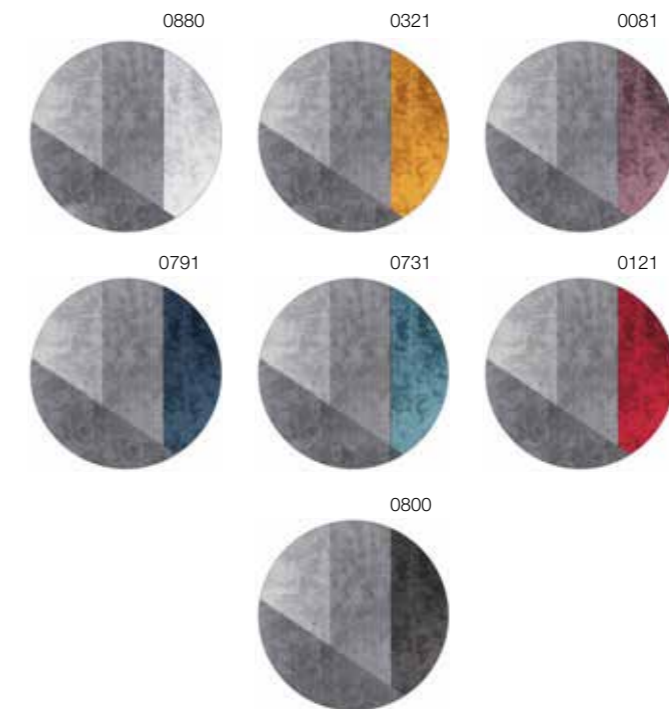

SOPHIE
 SET SCRIVANIA
 DESK SET
 SET DE BUREAU

IT— Linee semplici e raffinati accostamenti di colore per il set da scrivania Sophie composto da cinque elementi: vassoio, porta penne, porta oggetti, porta biglietti da visita e vaso mono fiore. Ogni pezzo è originale e interamente fatto a mano in terracotta smaltata con effetto opaco mono e bicolore. Leggere variazioni di forma, colore e misura sono da considerarsi un pregio e garanzia di creazione artigianale.

EN— Simple lines and refined colour combinations for Sophie desk set with five original and exclusive components, made entirely by hand in matte glazed one or two-colour terracotta. The set consists of five elements: tray, pen holder, object holder, visiting card holder and single-flower vase. Slight variations in shape, colour and size are to be considered a positive quality and a guarantee of their hand crafting.

F— Des lignes épurées et raffinées, des assortiments de couleurs pour le set de bureau Sophie composé de cinq pièces originales et exclusives, fabriquées à la main, en terre cuite émaillée, effet mat monochrome ou bicolore. Le set de bureau comprend cinq pièces: un plateau, un porte-stylos, un porte-objet, un porte-cartes de visite et un vase mono-fleur. Les petites différences de forme, de couleur et de taille sont une valeur ajoutée et assurent une fabrication artisanale de qualité.



5011-1011
 blu-bronzo
 blue-bronze
 bleu-bronze

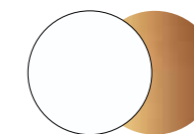

9010-1011
 bianco-bronzo
 white-bronze
 blanc-bronze



9005-1011
 nero-bronzo
 black-bronze
 noir-bronze



1019-1011
 castoro-bronzo
 beaver-bronze
 castor-bronze



8019-1011
 cacao-bronzo
 cocoa-bronze
 cacao-bronze

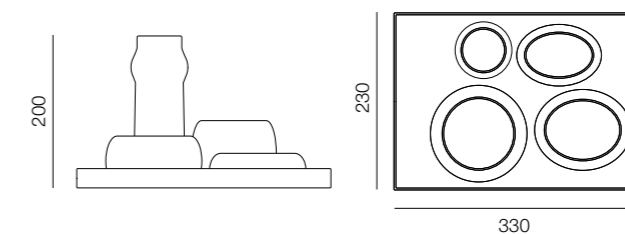

OLIVIA
VASI
VASES
VASES



INGRID
VASI
VASES
VASES





BLOOM
CIOTOLE
BOWLS
BOULES

IT - L'azienda si riserva in qualunque momento di apportare senza preavviso modifiche a prodotti, accessori, finiture.
EN - The manufacturer reserves the right to modify products, accessories and finishing at any time without prior notice.
FR - Le fabricant se réserve le droit de modifier les produits, accessoires et finitions à tout moment et sans préavis.

 IT - prodotti PROF in conformità alle norme UNI
EN - PROF products are according to UNI standards
FR - Les produits PROF sont conformes aux normes UNI

 IT - CEE standard
EN - CEE standard
FR - Norme CEE

 IT - Bassa emissione di formaldeide
EN - Low emission of formaldehyde
FR - Faible émission de formaldéhyde

 IT - Processo produttivo che rispetta l'ambiente
EN - Productions proces that respect the ambient
FR - Processus de production respectueux de l'environnement





Responsibility

October 2019

PROF

PROF srl
Via Cao de Villa 6/A
31020 Falzè di Piave, TV / Italy
T. +39 0438 903190 F. +39 0438 903228
P.I. - C.F. IT03134570260

www.profoffice.it info@profoffice.it

